



Investor Relations

Global Power EPC Company

CONTENTS

- 1 _ Company Information
- 2 _ Business Area
- 3 _ Technology
- 4 _ New Market & Biz.

Disclaimer

This material has been produced to provide investors with various information in order for them to get more understanding about KEPCO E&C based on the objective facts as best as we can.

However, the numbers in this material may be subject to change without notice and the company does not guarantee the correctness and completeness.

This presentation contains forward-looking statements, which are subject to risks, uncertainties, and assumptions.

No representation or warranty, expressed or implied, is made and no reliance should be placed on the accuracy, actuality, fairness, or completeness of the information presented.

This presentation does not constitute an offer or invitation to purchase or subscribe for any shares of the company, and no part of this presentation shall form the basis of or be relied upon in connection with any contract or commitment.

Company Overview



Korea's Leading Power Plant Engineering Company

- Korea's leading provider of design and engineering for nuclear, thermal and hydro-electric plants with over 40 years of experience
- Current 100% market share in nuclear power plant design in Korea
- The world's most competitive engineering company specialized in the two sectors: A/E and NSSS
- Expanding its business to Thermal EPC, energy-related business, environment-friendly business, etc.

Corporate Information

CEO & President	<p>Lee, Bae Soo</p> <ul style="list-style-type: none"> • Former vice president, KEPS • Former advisor, Samsung Engineering
Foundation Date	October 1, 1975
Employees	2,198 (As of June. 31, 2018)
Business Area	Power plant design & engineering, etc.

Ownership

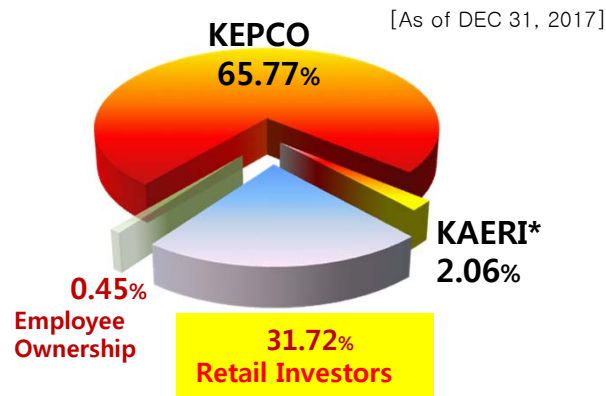

IPO Information

Shares Outstanding *Common shares 100%	38,220,000
Listing Date	December 14, 2009
Offered Securities	7,644,000

Dividends

[Unit : KRW]

FY	2014	2015	2016	2017
Dividend Propensity*	40%	25%	24%	40%
Amount (per a share)	575	200	110	220

* KAERI - Korea Atomic Energy Research Institute

* Dividend Propensity – Dividend/Net Income *100

Business Overview



Business Area

• Design & Engineering

- Nuclear Power Plant
- Thermal Power Plant
- Combined Cycle Power Plant
- Cogeneration Power Plant

• O&M (Operations & Maintenance)

- Technology & Engineering Support for Operating Power Plants



• Energy Solution Package

- Funding
- Consulting
- Procurement
- Post-management

• Environmentally-friendly Biz

- FGD System / DeNOx System
- ESCO, Renewable Energy
- Water Pollution Control
- Wastewater Treatment Facilities

• National Defense Project

- Government's task

Business Area – Design & Engineering

- All of the local nuclear power plants have been independently designed by KEPCO E&C since 1993
- Experiences of Coal fired/ CFBC Coal fired/ Combined Cycle/ Cogeneration Design

Major Project Experience

• Nuclear power

Reactor	Project	Project Period	Client
APR 1400	Shin-Kori #5,6	Apr '14 ~ Mar '22	KHNP
	UAE #1,2,3,4	Mar '10 ~ May '20	KEPCO
	Shin-Hanul #1,2	Dec '07 ~ Dec '19	KHNP
SMART	PPE BOP	Jun '16 ~ Nov '18	KAERI

• Others

Reactor	Project	Project Period	Client
Other	APR1400 US NRC DC design/licensing support - Stage 2	Aug '14 ~ May '19	KHNP

• Thermal power

Capacity (MW)	Project	Project Period	Client
1000x2	Gosung Greenpower	May '14 ~ Jul '21	SK E&C
1000x2	Gangneung Anin	Feb '14 ~ Sep '20	Samsung C&T
1000	Shin-seocheon	Jun '14 ~ Dec '19	Korea Midland Power
1000x2	Taeon #9,10	Jun '11 ~ Dec '17	Korea Western Power

Services performed

- Site selection and feasibility survey
- Engineering and design
- Construction/Project management, licensing support, quality assurance and inspection
- Support for purchasing, owner support, education/training



Business Area – O&M



Contribution to the Improvement of the Operating Power Plants' Operability, Efficiency and Safety

• O&M (Operations & Maintenance)

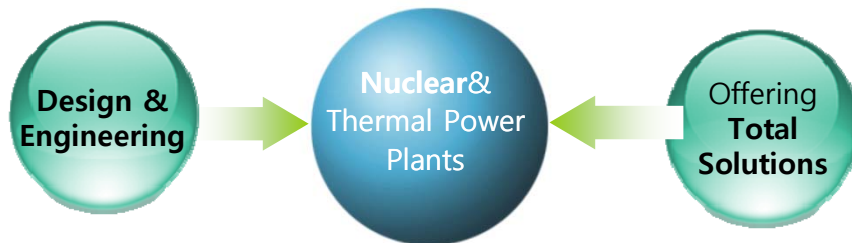

Services performed

- Technology support and engineering services
- Replacement design of key equipment
- Increase the output of power plants
- Design facility improvement of power plants in operation
- Technical support for license application and new regulatory requirements

• Nuclear Power Plants in Operation in Korea

Reactor	Project	First Power	Design
APR 1400	Shin-Kori #3	2016	KEPCOE&C
OPR 1000+	Shin-Wolsung #1,2	2012 / 2015	KEPCOE&C
	Shin-Kori #1,2	2011 / 2012	KEPCOE&C
OPR 1000	Hanul #5,6	2004 / 2005	KEPCOE&C
	Hanbit #5,6	2002 / 2002	KEPCOE&C
	Hanul #3,4	1998 / 1999	KEPCOE&C
	Hanbit #3,4	1995 / 1996	KEPCOE&C-WEC
CANDU PHWR	Wolsung #3,4	1998 / 1999	AECL-KEPCOE&C
	Wolsung #2	1997	AECL-KEPCOE&C
	Wolsung #1	1983	AECL-CANATOM
PWR	Hanul #1,2	1988 / 1989	Framatome
	Hanbit #1,2	1986 / 1987	Bechtel-KEPCOE&C
	Kori #3,4	1985 / 1985	Bechtel-KEPCOE&C
	Kori #1,2	1978 / 1983	WEC-Gilbert

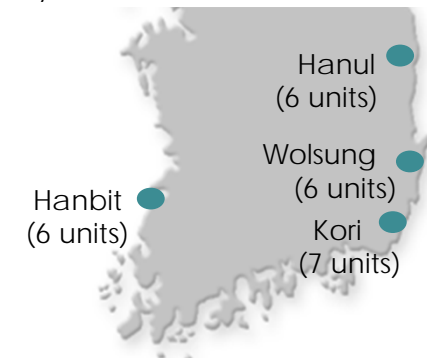

*The Uljin was renamed Hanul

*WEC – WestingHouse Electric.

*AECL – Atomic Energy of Canada Limited

Business Area – Energy Solution Package



Expanding its business areas to the overall value chain, including pre- and post-management of power plants

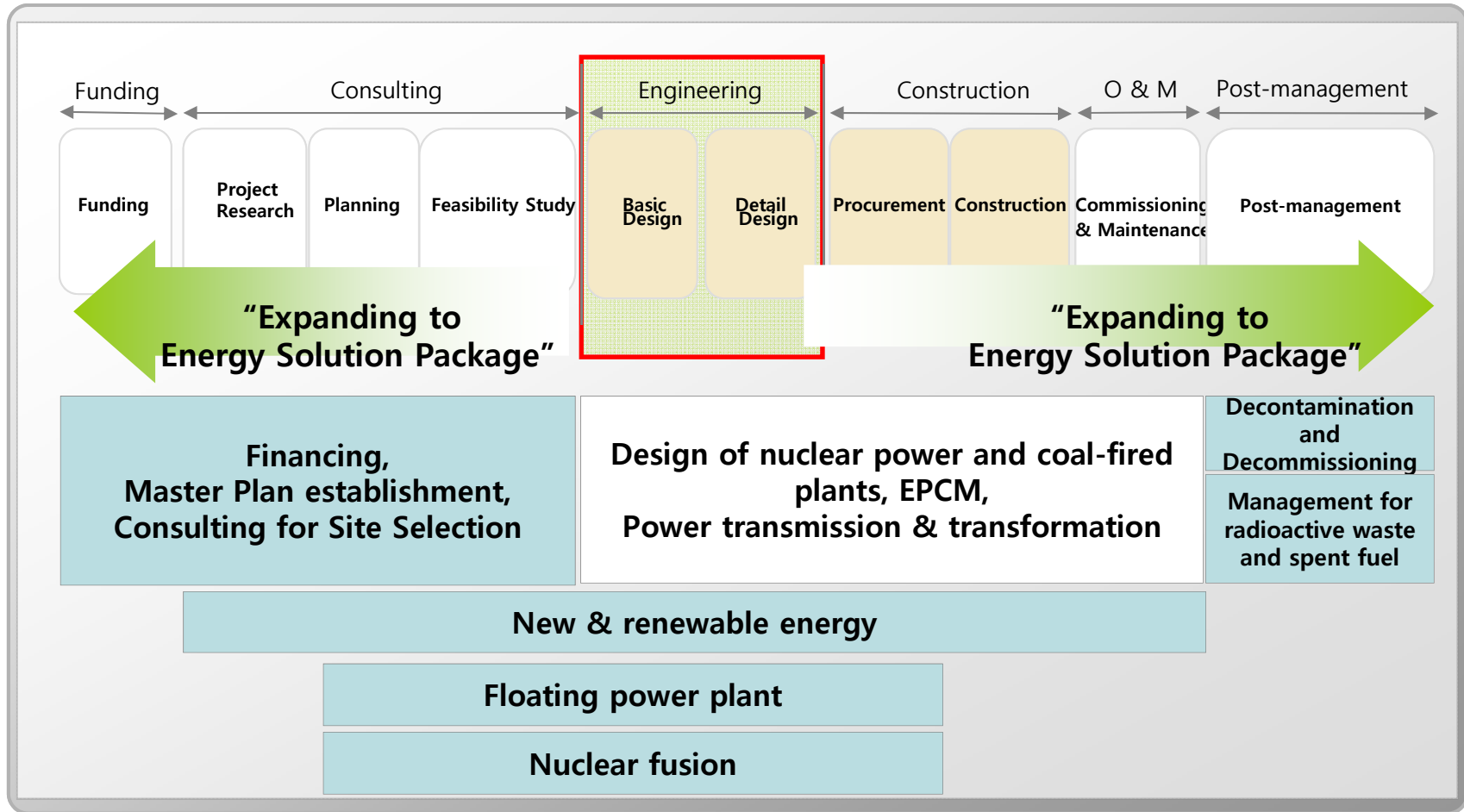

Technology – Nuclear Power Plant



Korean Nuclear Power Plant Design Development

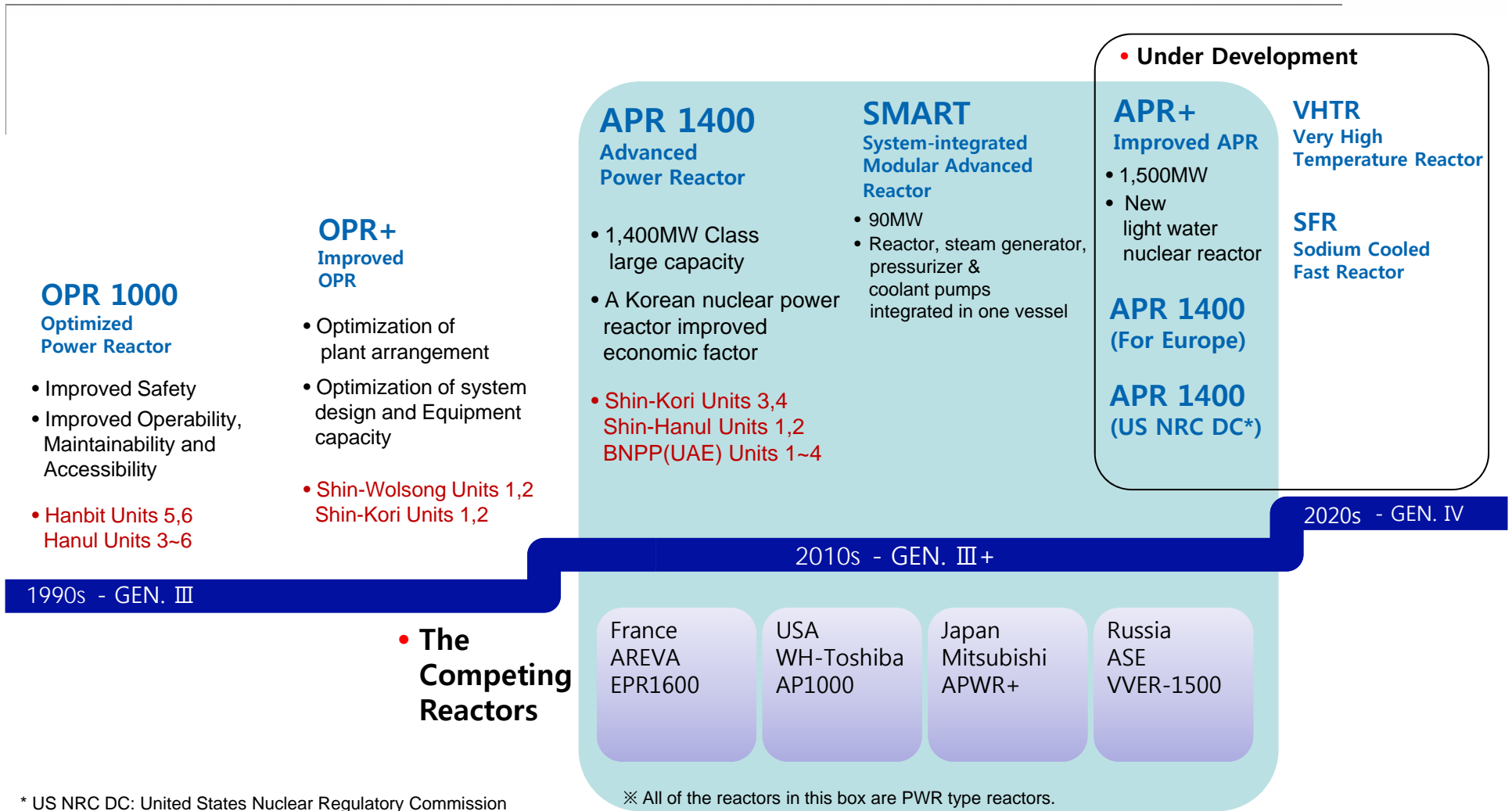

1990s - GEN. III

2010s - GEN. III+

2020s - GEN. IV

Technology – Thermal Power Plant

Coal-Fired Power Plant Design Development

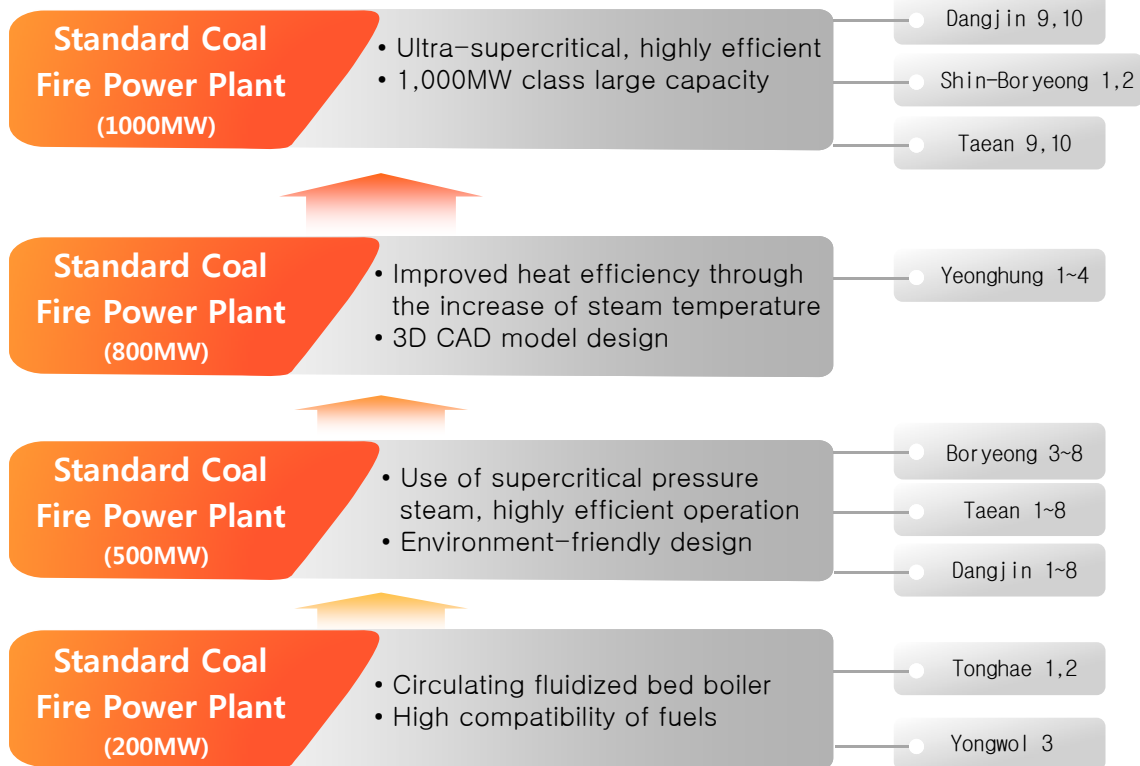

• **Dangjin #1~4- World Best Project Awarded**
<US, Power Engineering, 2001>



• **Boryeong #3,4 – World Best Project Awarded**
<US, Electric Power International, 1996>

Focus on 10 core businesses in 5 areas



New Growth Businesses for KEPCO E&C

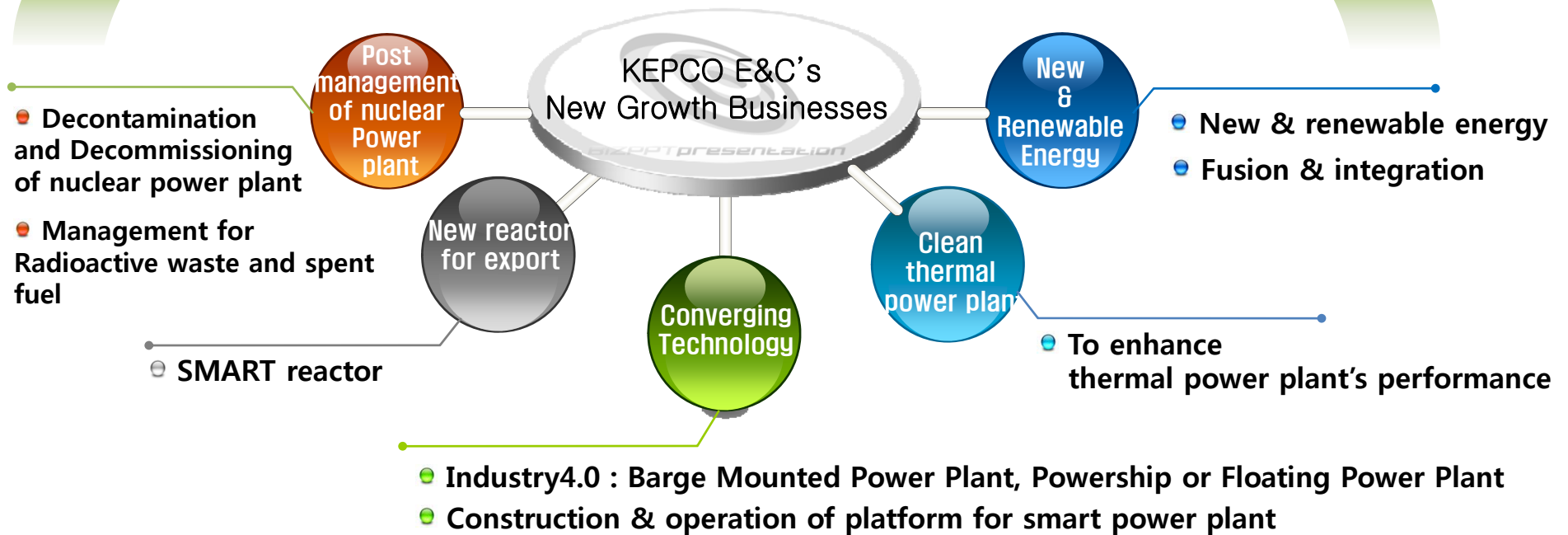

Nuclear power plans – Small Units & Others

• SMART export plan

- **SMART - Integral type reactor**
 - steam generator, pressurizer, and coolant pump are all integrated into one vessel.
- 90MW of electricity output, 40,000ton/day of desalination capacity
 - can supply a city with a population of 100,000
- Year 2012 : Acquired SDA(standard design approval) in Korea. (the first SDA as integral type reactor in the world)
- Year 2013 : Cooperation agreement with Saudi Arabia on the introduction of SMART in Saudi Arabia
- Year 2015 : Signed a deal to jointly invest in studying the prospect of building at least two SMART in Saudi Arabia
- Year 2017 : Performing PPE(Pre-Project Engineering) to build two SMARTs in Saudi Arabia

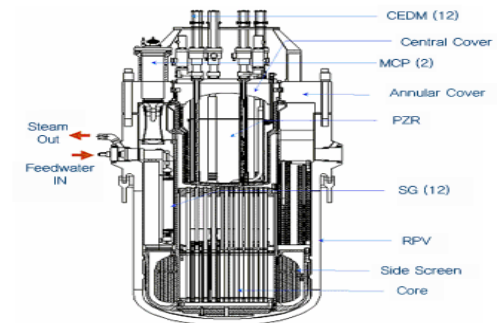
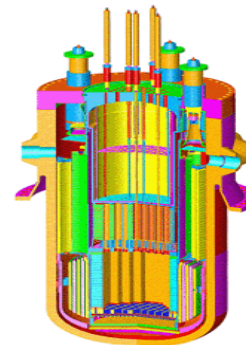

• Participation in the international project – ITER

- International Thermonuclear Experimental Reactor(ITER) Project
- 7 countries that run the project – EU, U.S., Russia, China, Japan, India and South Korea
- Total amount of orders KEPCO E&C has received : 57.3 KRW bn. (expecting more orders)

Nuclear power plans – Decommissioning



• Decommissioning

▫ The oldest reactors in Korea

Plant	Commercial operation	Planned close	
KORI #1	1978	2017	license extended 2007 → 2017
Wolsung #1	1983	2012	license extended 2012 → 2022
KORI #2	1983	2023	
KORI #3	1985	2024	
KORI #4	1986	2025	

- Kori-1, the first nuclear power plant in Korea, is scheduled to become the first reactor to go dormant.
 - it had 30-year lifespan expired in 2007, but gained approval of additional 10-year operation.
- The Korean government announced in June, 2015 that the development of the 17 decommissioning techniques that have yet to be finished would be completed by 2021.

• Decommissioning?

- series of various follow-up processes upon the completion of operation regarding nuclear power plant facilities.
- Minimization of radioactive contamination from facilities after decontamination and decommissioning.
- Republic of Korea and UK have strengthen cooperation in the research on nuclear decommissioning.

• Decommissioning Flow

